



F60 SERIES

MECHANICAL KEYBOARDS

User Guide

使用说明书

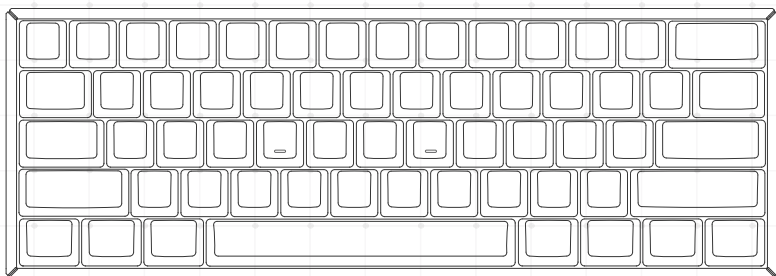

**New Design
New Series**

Designed by IQUNIX

English Version

Start Reading →

Please read this manual guide and cautions to ensure that using this product correctly.

Details

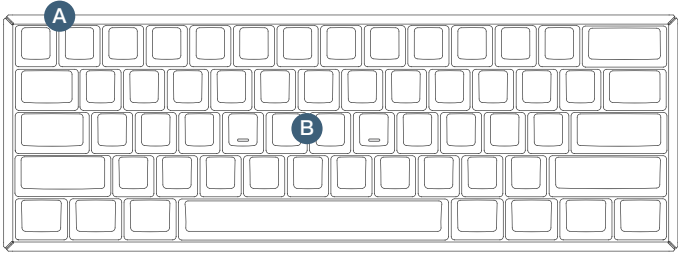

A Type-C Port

B Indicator

C Feet

D Silicone Pads

Product Specification

Product Name: F60

Keyboard Type: Mechanical Keyboard

Key Quantity: 61 Keys

Keyboard Material: Aluminum Alloy Case + PBT Keycaps

Character Technology: Dye Sublimation

Large Key Structure: Costar Stabilizers

Rating: 5V=1A

Connect Interface: USB Type-C

Cable Length: 180cm



Dimensions: 295×104.5×33.5mm

Phone: (+86) 400-1788-905

Web: www.IQUNIX.com

Support E-mail: support@iqunix.store

LED Indicator Status Description

 White Light Blinks 5 Times	 White Light On	 White Light Blinks 3 Times
Reset to Default	CapsLock On	Keys Combinations Switching

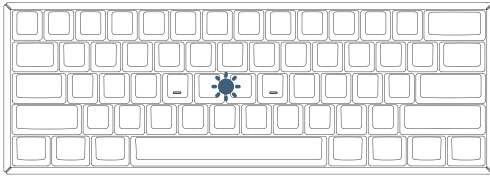

Wired Connection Mode

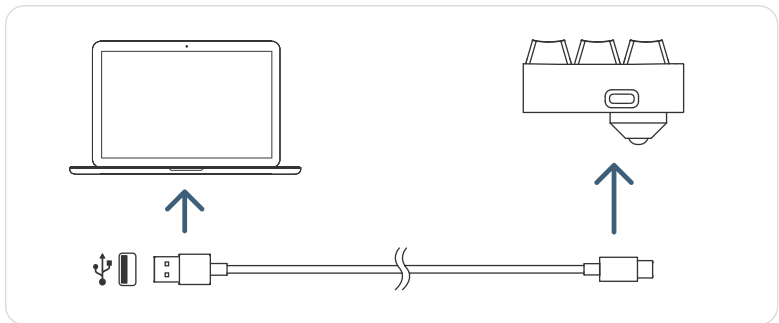

- 1 Plug the USB cable into your device.
- 2 Start using your keyboard.

Mac / Windows Layout Switching



Hold for 5 seconds to switch the layout between macOS and windows systems.

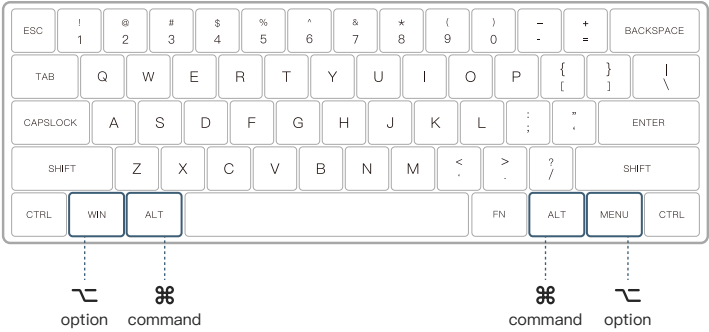

FN Keys Combinations

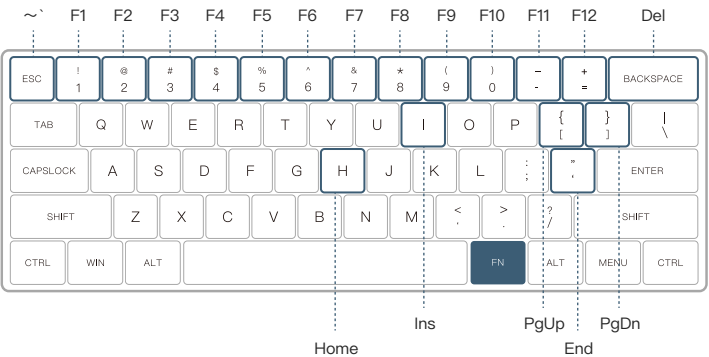

FN

Function Keys Combinations

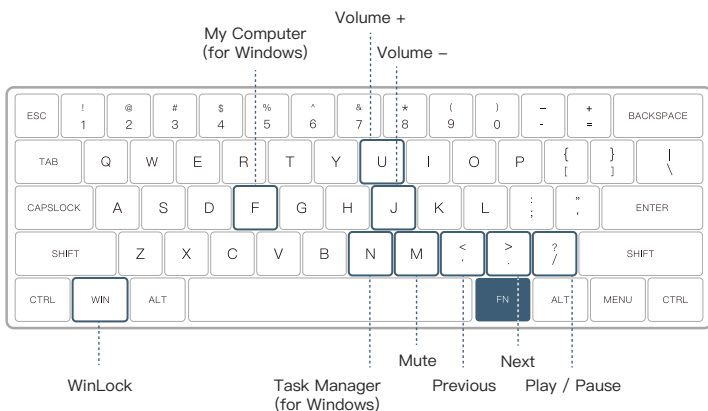

FN

LED Keys Combinations (RGB Version)

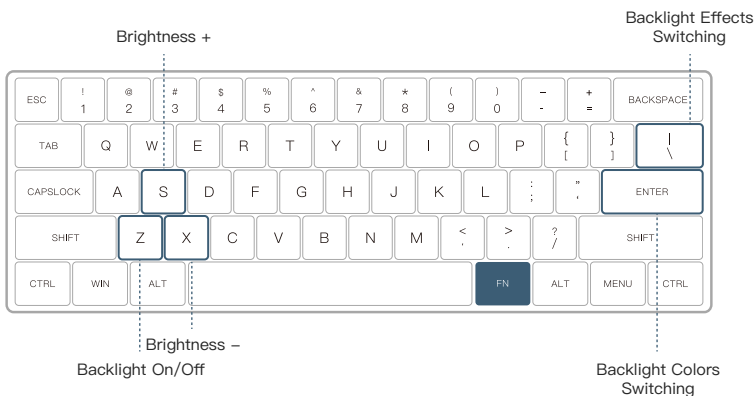



Arrow Keys Combinations

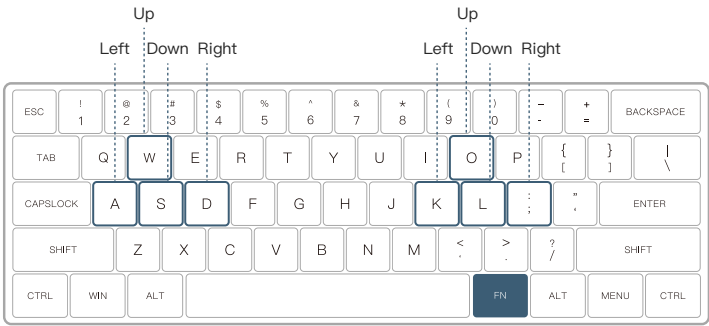

Special Keys Combinations (Hold for 5 Seconds)

MAC / Windows
Layout Switching



Swap CapsLock and Left Ctrl

Arrow Keys On / Off



To learn more details, please reach out to us on official website and social media.

Official website: www.IQUNIX.store

Follow us:
IQUNIX



Download IQUNIX
Official App



简体中文版

开始阅读使用 →

使用前请仔细阅读此说明书和注意事项
以保证您能正确的使用此产品

自产品细节

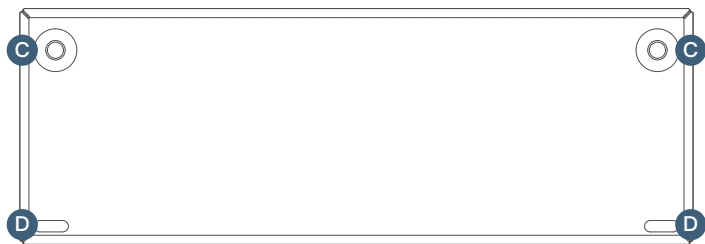
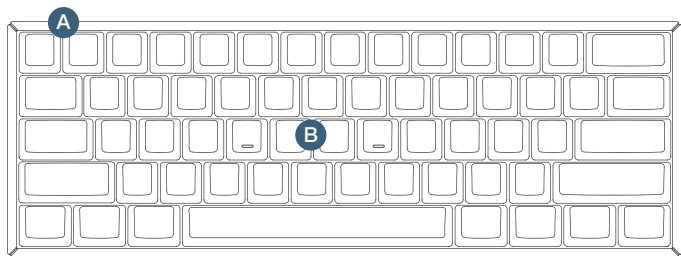

A Type-C接口

B 指示灯

C 脚撑

D 硅胶垫

基本参数

产品名称： IQUNIX F60 2020 缤纷版

产品型号： F60 2020

保修期限： 12个月

连接方式： USB有线

支持系统： Windows、macOS、Linux

执行标准： Q/YSFB 012—2020

产品重量： 790g

产品尺寸： 295.2mm*103.5mm*40mm

制造商： 深圳市银色风暴科技有限公司

官方网址： www.iQunix.com

服务电话： 400-1788-905

官方联系邮箱： Hello@iQunix.com

☀ 指示灯颜色和状态说明

 白色灯光 闪烁5次	 白色灯光 长亮	 白色灯光 闪烁3次
恢复出厂设置	Caps Lock开启	组合键长按切换

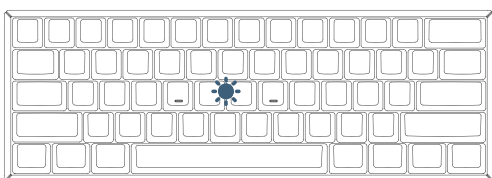

🔗 有线连接

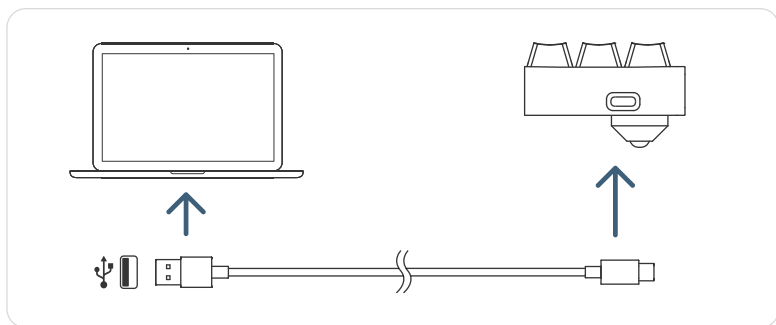

- 1 将数据线USB-A端接入电脑；
- 2 将数据线USB-C端接入键盘；
- 3 开始使用您的键盘。

切换为MAC布局对应的按键



长按5秒即可切换Mac、Windows系统键位布局



FN 按键组合键

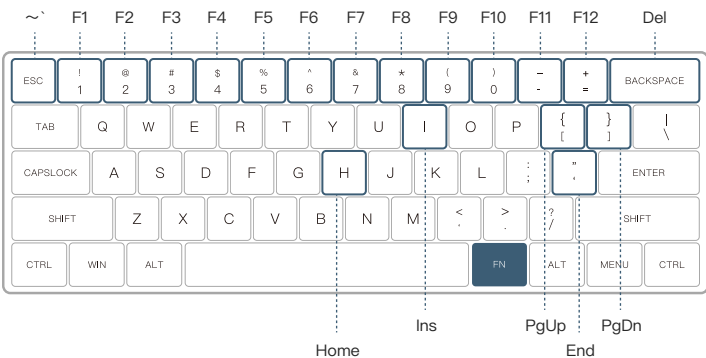

FN

多媒体功能组合键

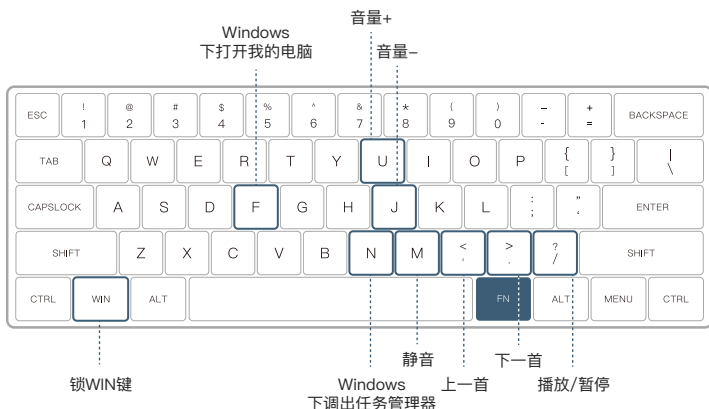

FN

灯光组合键 (RGB版)



FN

方向组合键



FN

特殊组合键 (长按5秒实现)

Mac、Windows
系统键位布局切换

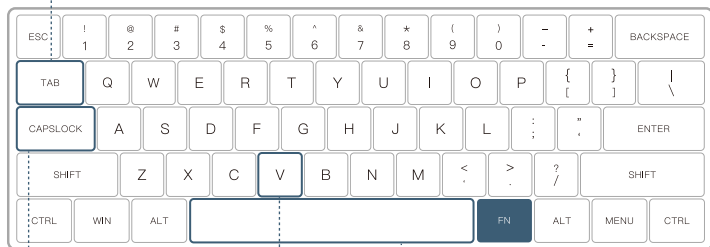

CapsLock和
左Ctrl互换

独立方向键开关



了解更多详细信息请关注官方
微信公众号或下载IQUNIX APP



官方微信公众号



官方APP



Brand/品牌:

IQUNIX

Origin/产地:

中国

China

Manufacturer/制造商:

深圳市银色风暴科技有限公司

Shenzhen silver storm Technology Co., Ltd

Service telephone/服务热线:

400-1788-905